



# SPARE PARTS LIST

ROBOTIC LAWN MOWERS

SILENO City, 2019-

**A** GARDENA SILENO city  
BODY

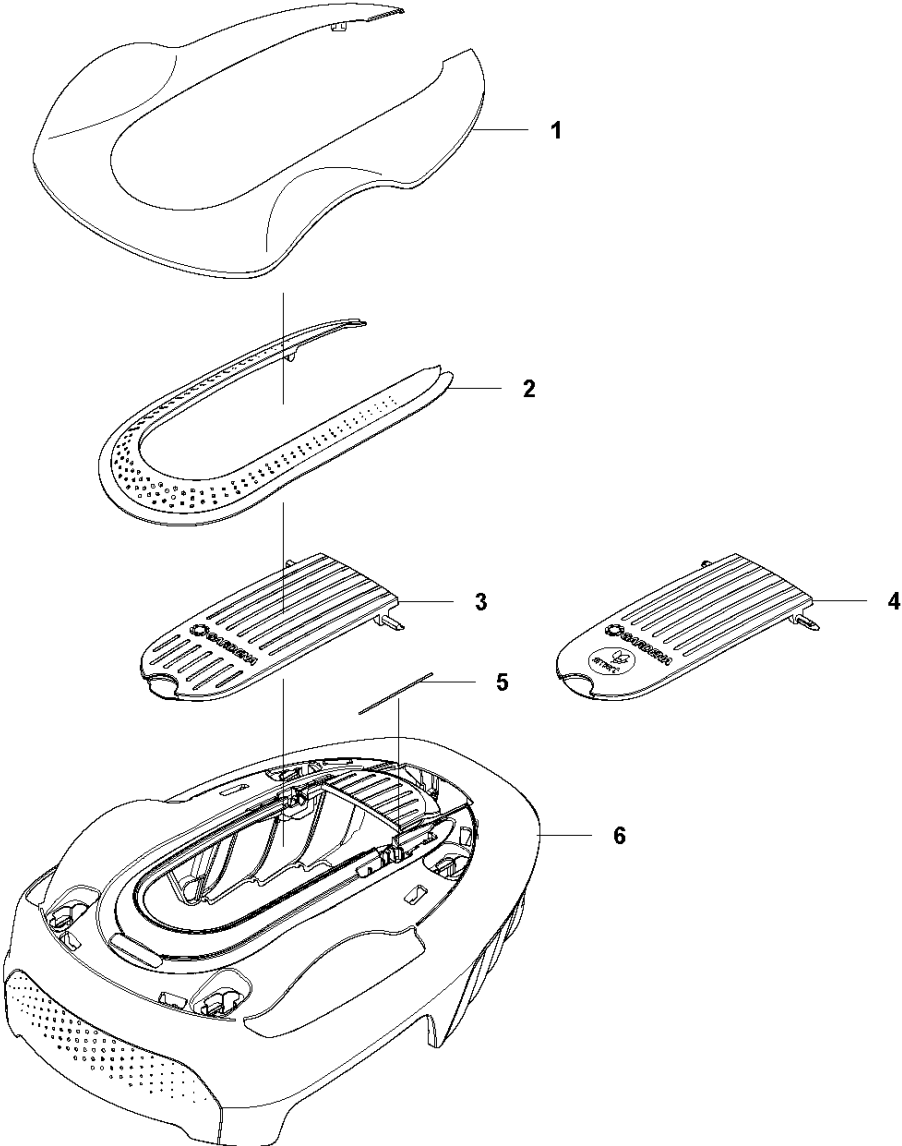

## KÅPA

SILENO City, 2019-

Ref	Artikelnr	Beskrivning	Anmärkning	ANT SATS AL
1	582 82 45-01	KÅPA	Top Cover	1
2	582 91 65-01	RAM	Frame	1
3	582 84 42-01	LUCKA	Hatch	1
4	593 34 86-01	LUCKA	Hatch	1
5	588 47 02-01	FJÄDER	Spring	2
6	591 44 45-01	BODY ASSY	Body ass	1

**B** GARDENA SILENO city  
CHASSIS UPPER

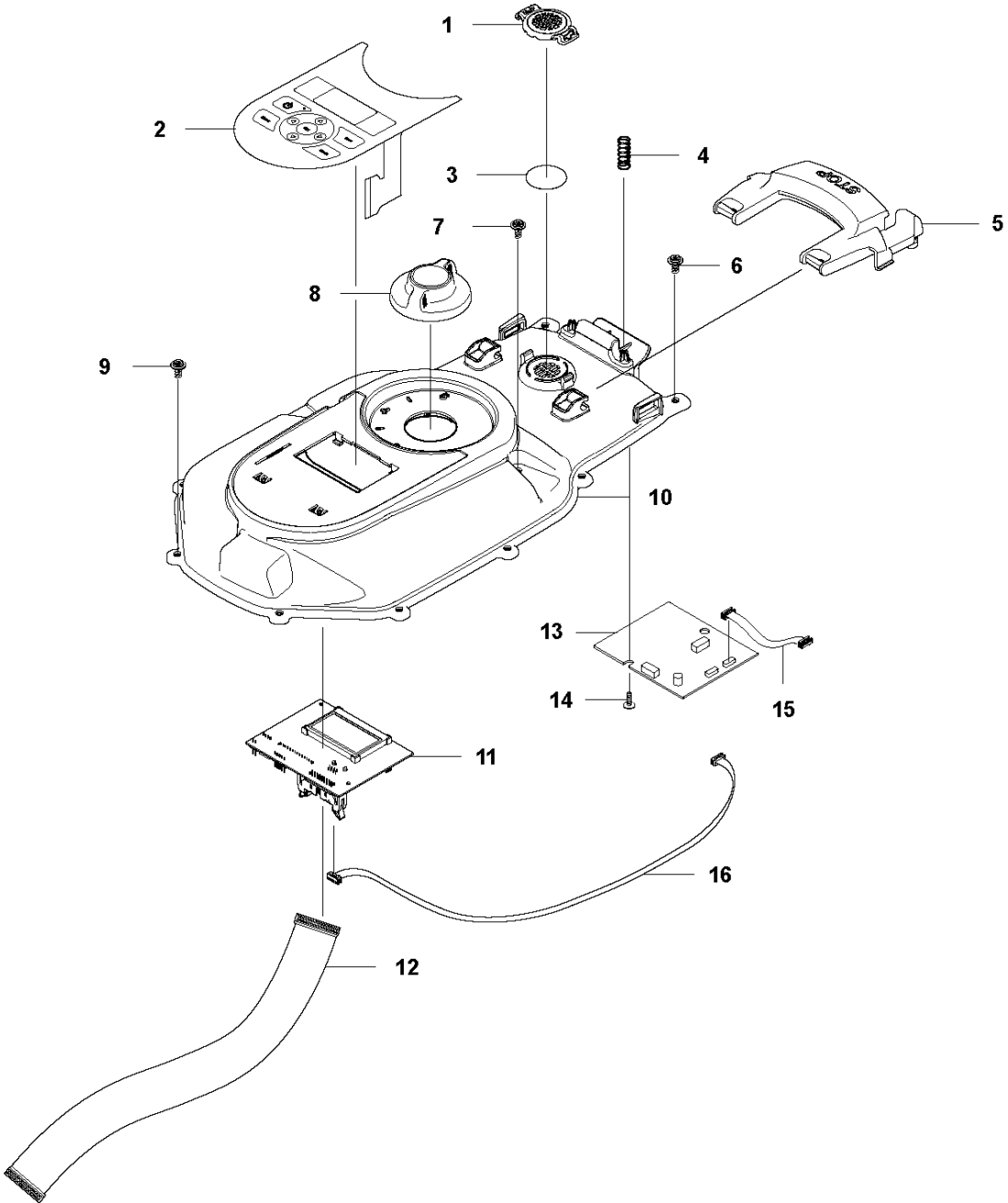

Ref	Artikelnr	Beskrivning	Anmärkning	ANT SATS AL
1	586 03 89-01	KÅPA	Cover	1
2	583 79 10-01	TANGENTBORD	Keyboard	1
3	576 92 15-01	LUFTFILTER	Air Filter	1
4	576 24 22-01	FJÄDER	Spring	2
5	591 45 25-01	BUTTON ASSY	Button Assy	1
6	574 45 01-01	SKRUV ITXPANT	Screw	2
7	574 45 01-01	SKRUV ITXPANT	Screw	2
8	587 98 65-01	KNOPP	Knob	1
9	574 45 01-01	SKRUV ITXPANT	Screw	8
10	582 82 41-02	CHASSI	Chassis	1
11	592 91 00-01	KRETSKORT	Printed Circuit Assy	1
12	590 11 06-01	KABLAGE KPL	Cable Assy	2
13	588 13 62-03	KRETSKORT	Printed Circuit Assy	1
14	574 45 01-01	SKRUV ITXPANT	Screw	2
15	579 70 86-01	KABLAGE KPL	Wiring Assy	1
16	593 14 89-01	KABLAGE KPL		1

**C** GARDENA SILENO city  
CHASSIS LOWER

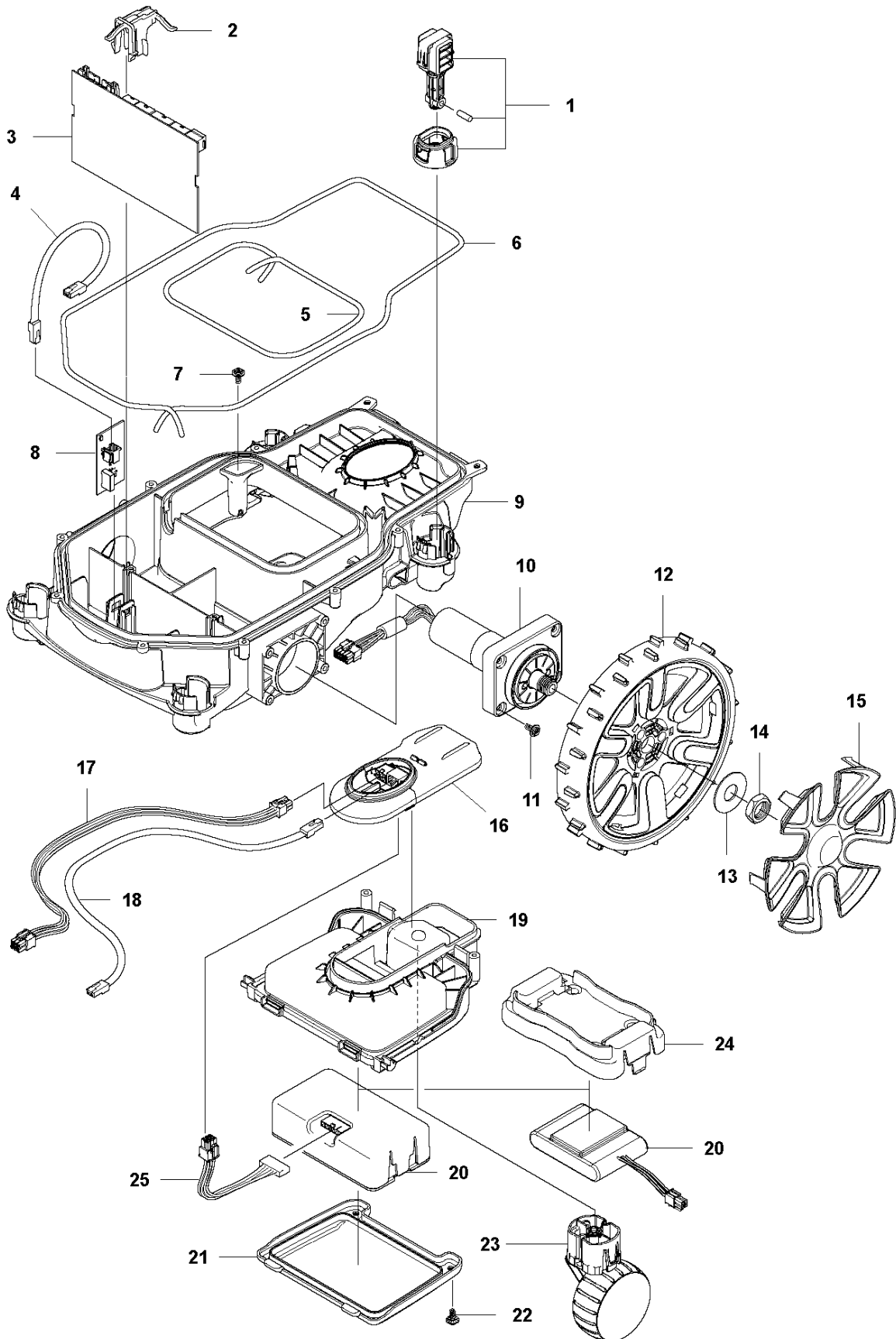

Ref	Artikelnr	Beskrivning	Anmärkning	ANT	SATS
				AL	
1	590 77 07-01	COLUMN ASSY	Column Assy	4	
2	591 47 42-01	KLÄMMA	Clip	1	
3	592 90 99-01	KRETSKORT	Printed Circuit Assy	1	
4	589 35 08-01	KABLAGE KPL	Wiring Assy	1	
5	574 87 47-11	TÄTNINGSLIST	Seal Strip	1	
6	574 87 47-10	TÄTNINGSLIST	Seal Strip	1	
6	593 26 57-01	SEAL KIT	Seal Kit	1	
7	574 45 01-01	SKRUV ITXPANT	Screw	2	
8	592 90 98-01	KRETSKORT	Printed Circuit Assy	1	
9	582 82 40-01	CHASSI	Chassis	1	
10	587 44 94-04	MOTOR KIT	Motor Kit	2	
11	574 45 01-01	SKRUV ITXPANT	Screw	8	
12	590 58 71-01	HJUL KPL	Wheel assy	2	
13	586 21 06-01	BRICKA	Washer	2	
14	731 43 24-01	HEXAGON TUNN MUTTER	Hexagon Thin Nut	2	
15	590 66 02-01	NAVKAPSEL	Hub Cap	2	
16	593 09 46-01	SENSOR ASSY	Sensor Assy	1	
17	589 35 11-01	KABLAGE KPL	Wiring Assy	1	
18	589 35 10-01	KABLAGE KPL	Wiring Assy	1	16
19	582 82 46-01	HUS	Housing	1	
20	589 58 62-01	BATTERI	Battery	1	
20	593 24 72-01	BATTERI	From serial no 185004490	1	
21	582 82 49-01	KÅPA	Cover	1	
22	574 45 01-01	SKRUV ITXPANT	Screw	2	
23	589 30 08-01	HJUL KPL	Wheel assy	1	
24	501 92 61-01	HÅLLARE		1	
25	591 20 36-02	KABLAGE KPL		1	

**D** GARDENA SILENO city  
BLADE MOTOR & CUTTING EQUIPMENT

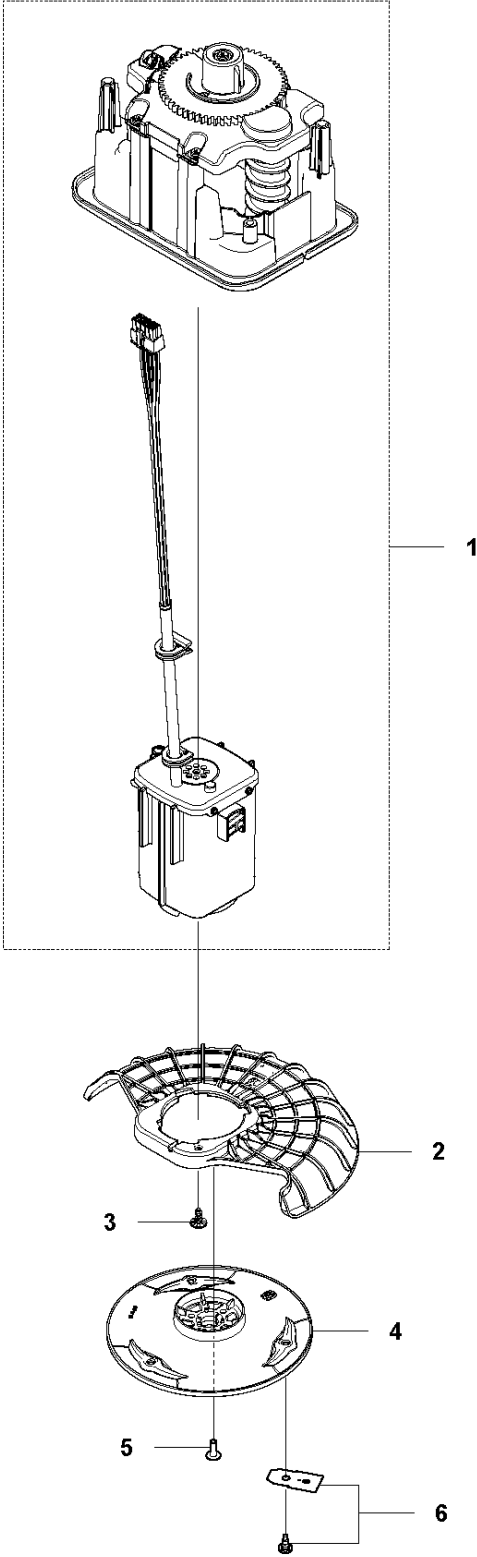



## KNIVMOTOR OCH SKÄRUTRUSTNING

SILENO City, 2019-

Ref	Artikelnr	Beskrivning	Anmärkning	ANT	SATS
1	593 82 14-01	KLIPPSYSTEM	Cutting System	1	2
2	589 35 07-01	SKYDD	Guard	1	
3	574 45 01-01	SKRUV ITXPANT	Screw	1	
4	589 34 68-01	KNIVDISK	Cutting Disc	1	
5	590 50 87-01	SCREW	Screw	3	
6	580 48 91-01	KNIV	4087-00.701.00	1	
6	966 80 95-01	KNIV	Blade	1	
6	Gardena40872 0	TBD		1	

**E** GARDENA SILENO city  
CHARGING STATION

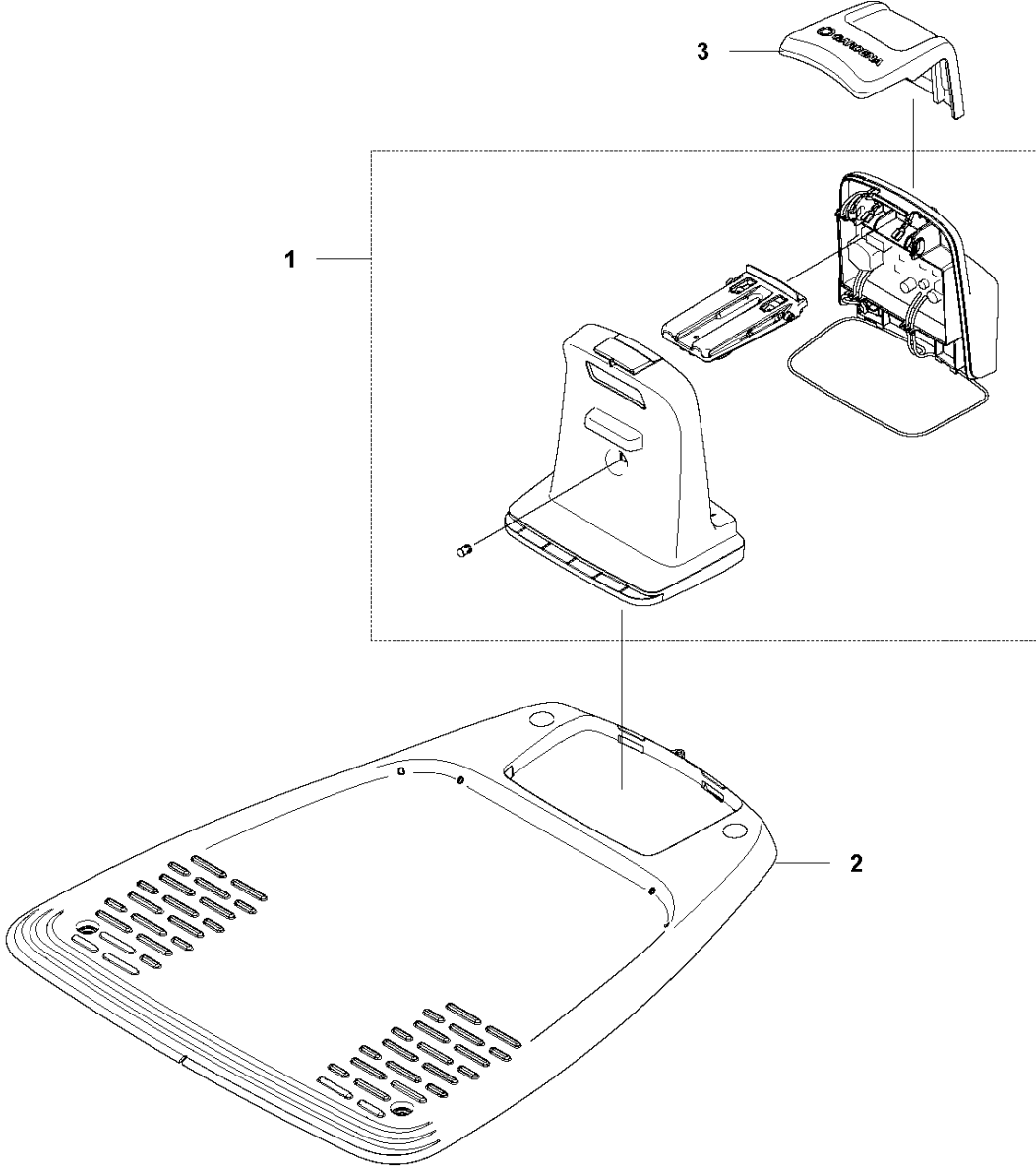

Ref	Artikelnr	Beskrivning	Anmärkning	ANT SATS AL
1	593 24 64-02	CHARGING TOWER	Charging station	1
2	582 78 43-01	PLATTA	Plate	1
3	593 30 72-01	HATT	Cap	1

**F** GARDENA SILENO city  
INSTALLATION ACCESSORIES

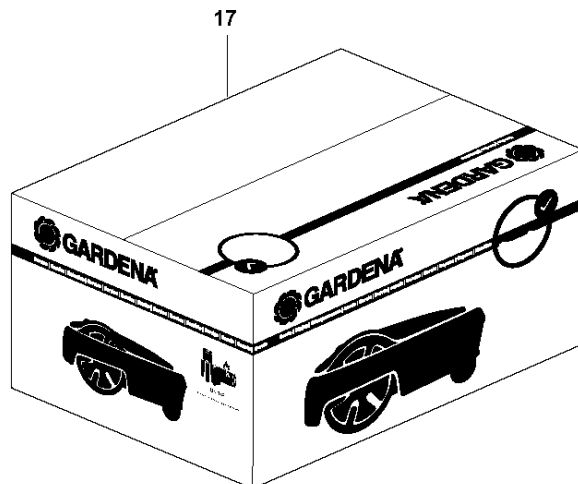
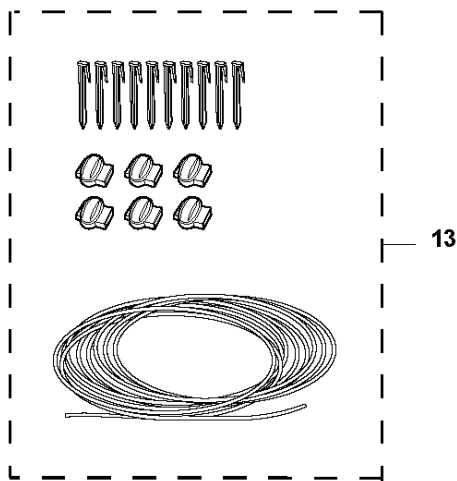
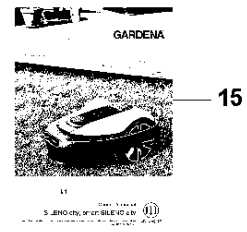
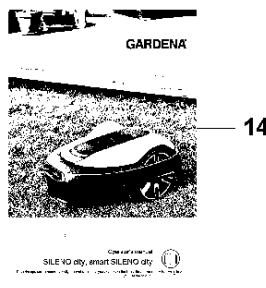
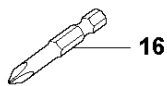
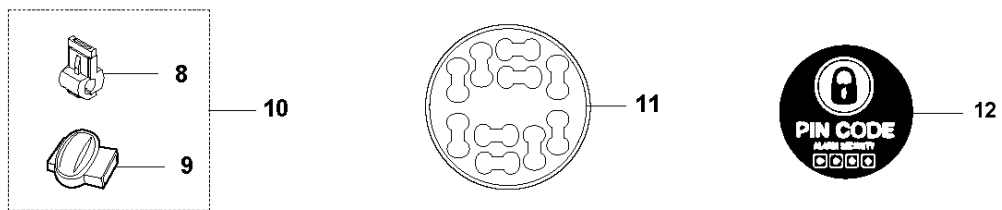
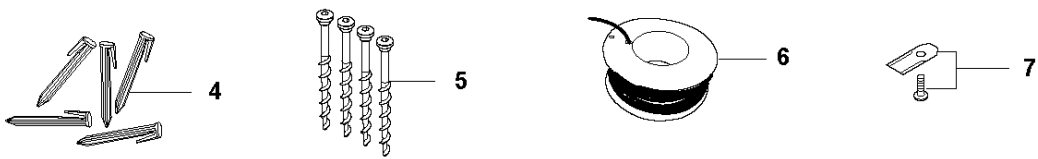
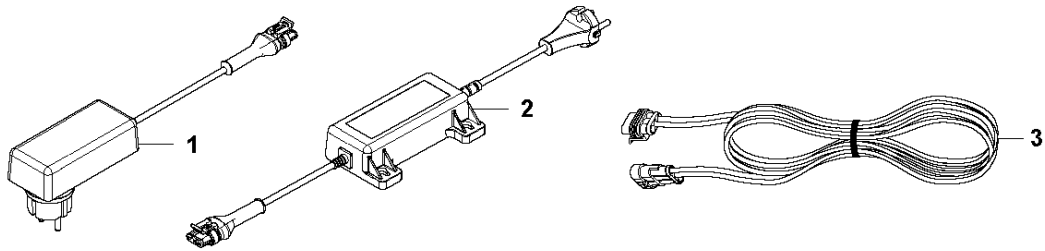

Ref	Artikelnr	Beskrivning	Anmärkning	ANT	SATS
				AL	
1	593 16 36-01	DRIVENHET	Power Unit EU	1	
2	590 44 22-02	DRIVENHET	Power Unit UK	1	
2	584 86 26-01	DRIVENHET	EU	1	
2	584 86 26-05	DRIVENHET	Power Supply Unit AU/NZ	1	
2	590 44 22-03	DRIVENHET	Power Unit CH	1	
3	579 82 51-01	KABLAGE KPL	Low Voltage Cable (20 m)	1	
3	579 82 51-02	KABLAGE KPL	Low Voltage Cable (10 m)	1	
3	579 82 51-03	KABLAGE KPL	Low Voltage Cable (3 m)	1	
3	579 82 51-04	KABLAGE KPL	Low Voltage Cable (5 m)	1	
4	966 80 98-01	KLAMMER	Staple	1	
4	Gardena40920	TBD		1	
5	575 23 86-06	SCREW KIT	Screw Kit	1	
6	967 10 48-01	VAJER	Wire	1	
6	Gardena405820	TBD		1	
6	966 80 96-01	VAJER	Wire	1	
6	Gardena408820	TBD		1	
7	580 48 91-01	KNIV	4087-00.701.00	1	
7	966 80 95-01	KNIV	Blade	1	
7	Gardena408720	TBD		1	
7	577 60 65-05	BLADE SET	Blade Set	1	
7	577 60 66-04	BLADE SET	Blade Set	1	
8	535 12 90-01	KOPPLING	Connector	1	10
9	501 98 02-01	KOPPLING	Coupler	1	10
10	966 80 97-01	KOPPLING	Coupler	1	
10	Gardena408920	TBD		1	
10	579 04 81-01	TILLBEHÖRSPÅSE	Accessory Bag	1	
11	586 27 79-01	ETIKETT	Sticker	1	
12	502 40 53-01	DEKAL	Label	1	
13	967 10 49-01	REPARATIONSSATS	Repair Kit	1	
13	Gardena405920	TBD		1	
14	115 89 45-01	BRUKSANVISNING	Operator's Manual, Swedish	1	
14	115 89 45-06	BRUKSANVISNING	Operator's Manual, Danish	1	
14	115 89 45-11	BRUKSANVISNING	Operator's Manual, Finnish	1	
14	115 89 45-21	BRUKSANVISNING	Operator's Manual, Norwegian	1	
14	115 89 45-26	BRUKSANVISNING	Operator's Manual, English	1	
14	115 89 45-31	BRUKSANVISNING	Operator's Manual, French	1	
14	115 89 45-36	BRUKSANVISNING	Operator's Manual, Dutch	1	
14	115 89 45-41	BRUKSANVISNING	Operator's Manual, Italian	1	
14	115 89 45-46	BRUKSANVISNING	Operator's Manual, Spanish	1	
14	115 89 45-51	BRUKSANVISNING	Operator's Manual, German	1	
14	115 89 45-58	BRUKSANVISNING	Operator's Manual, Hungarian	1	
14	115 89 45-59	BRUKSANVISNING	Operator's Manual, Portuguese	1	
14	115 89 45-60	BRUKSANVISNING	Operator's Manual, Bulgarian	1	
14	115 89 45-61	BRUKSANVISNING	Operator's Manual, Polish	1	
14	115 89 45-68	BRUKSANVISNING	Operator's Manual, Slovak	1	
14	115 89 45-84	BRUKSANVISNING	Operator's Manual, Slovenian	1	
14	115 89 45-90	BRUKSANVISNING	Operator's Manual, Czech	1	
15	115 89 46-01	QUICK GUIDE	Quick Guide, Swedish	1	
15	115 89 46-06	QUICK GUIDE	Quick Guide, Danish	1	
15	115 89 46-11	QUICK GUIDE	Quick Guide, Finnish	1	
15	115 89 46-21	QUICK GUIDE	Quick Guide, Norwegian	1	

Ref	Artikelnr	Beskrivning	Anmärkning	ANT SATS AL
15	115 89 46-26	QUICK GUIDE	Quick Guide, English	1
15	115 89 46-31	QUICK GUIDE	Quick Guide, French	1
15	115 89 46-36	QUICK GUIDE	Quick Guide, Dutch	1
15	115 89 46-41	QUICK GUIDE	Quick Guide, Italian	1
15	115 89 46-46	QUICK GUIDE	Quick Guide, English	1
15	115 89 46-51	QUICK GUIDE	Quick Guide, German	1
15	115894658	TBD	Quick Guide, Hungarian	1
15	115894659	TBD	Quick Guide, Portuguese	1
15	115 89 46-61	QUICK GUIDE	Quick Guide, Polish	1
15	115 89 46-60	QUICK GUIDE	Quick Guide, Bulgarian	1
15	115 89 46-68	QUICK GUIDE	Quick Guide, Slovak	1
15	115 89 46-90	QUICK GUIDE	Quick Guide, Czech	1
15	115 89 46-84	QUICK GUIDE	Quick Guide, Slovenian	1
16	596 33 98-01	VERKTYG	Bit for Automower blades MOQ 5 pcs	1
17	595 96 34-01	KARTONG		1

**G** GARDENA SILENO city  
ACCESSORIES

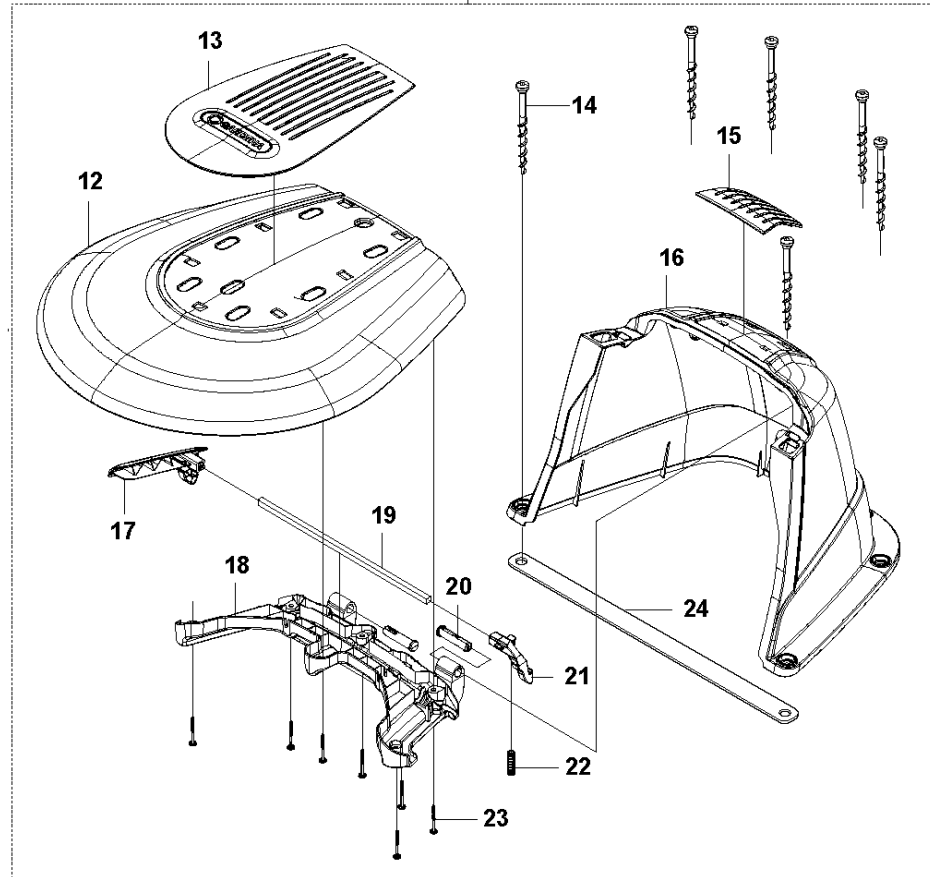
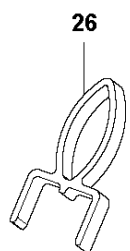
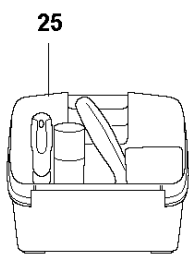
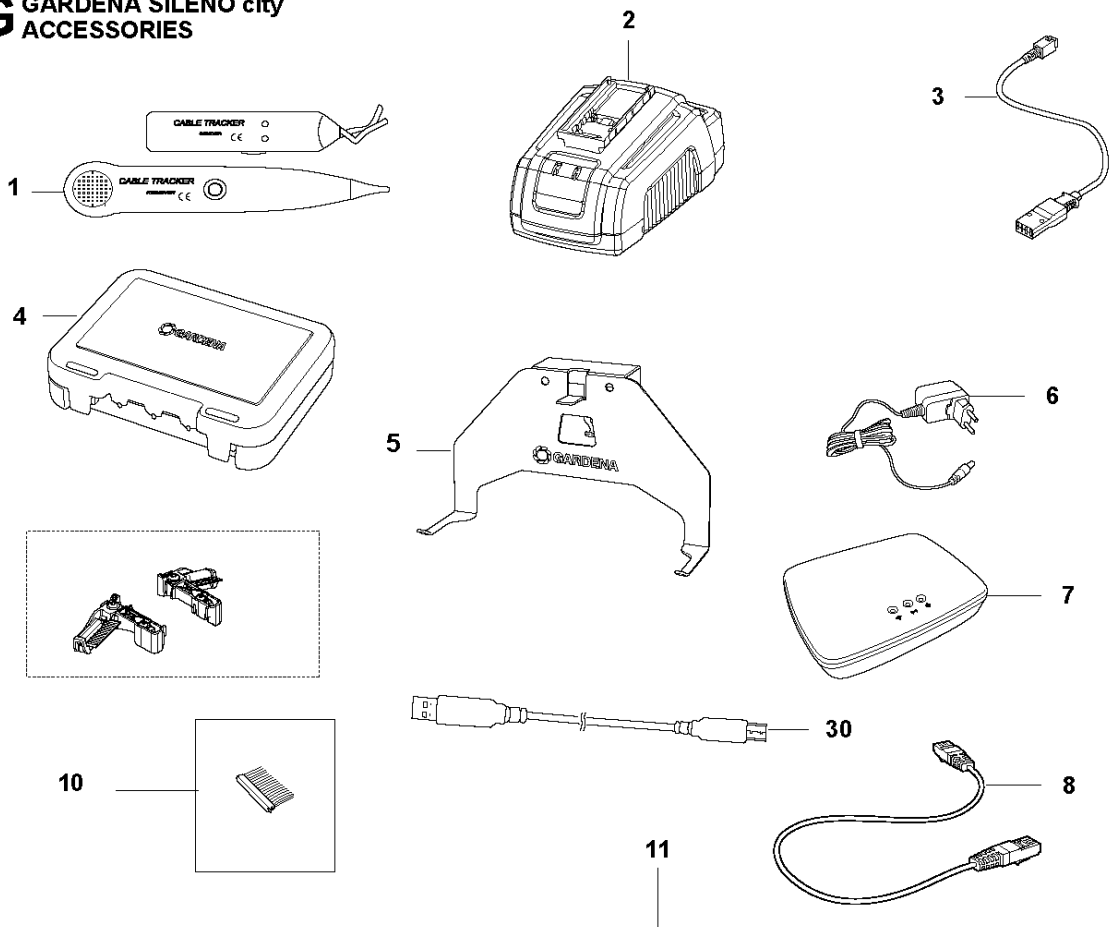

Ref	Artikelnr	Beskrivning	Anmärkning	ANT	SATS	AL
1	577 60 68-01	TESTUTRUSTNING	Test Equipment	1		
2	588 40 84-01	LADDARE	Charger	1		
3	588 20 26-01	KABLAGE KPL	Cable Assy	1		
4	967 10 45-01	KOPPLING	Connector	1		
4	Gardena405620	TBD		1		
5	592 61 66-01	WALL HANGER	Wall Hanger	1		
5	Gardena404520	TBD		1		
6	589 20 95-01	ADAPTER	Adapter	1		
7	596 50 55-01	AGGREGAT	19005-00.600.00	1		
8	501 65 70-01	VAJER	Wire	1		
9	592 61 58-01	BORSTSATS	Brush Kit	1		
10	593 37 37-01	BORSTSATS	Brush Kit	1		
11	586 80 17-01	HUS	Housing	1		
12	587 91 63-01	TÄCKLOCKSSATS	Cover Kit	1	11	
13	587 91 64-01	TÄCKLOCKSSATS	Cover Kit	1	11	
14	575 23 86-01	SCREW KIT	Cover	1	11	
15	586 69 46-01	KÅPA	Cover	1	11	
16	586 69 42-01	BALK	Beam	1	11	
17	586 69 47-01	HANDTAG	Handle	1	11	
18	585 32 41-02	STÅNG	Rod	1	11	
19	586 69 48-01	SPÄRRHAKE	Latch	1	11	
20	585 34 15-01	GÅNGJÄRNSPINNE	Hinge Pin	2	11	
21	575 54 33-14	SCREW	Screw	8	11	
22	575 23 86-01	SCREW KIT	Screw Kit	1	11	
23	580 51 14-01	FJÄDER	Spring	1	11	
24	590 87 81-01	STÖD	Support	1		
25	967 10 43-01	MAINTENANCE KIT	Maintenance Kit	1		
25	406720	TBD		1		
26	593 21 56-01	GAFFEL	Fork	1		
30	577 51 81-02	KABEL		1		